

RFMD 

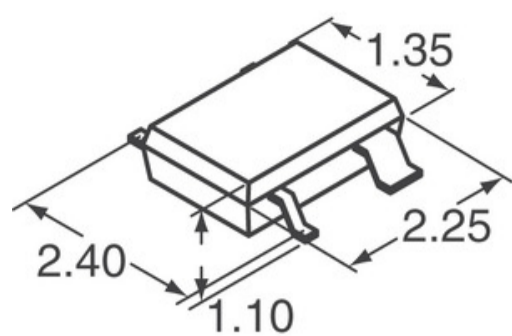

Gambar mungkin representasi.
Lihat spesifikasi untuk perincian produk.

SGA-8343Z

Nombor Bahagian: **SGA-8343Z**
 Penerangan Produk: IC RF AMP PCS 0HZ-6GHZ SOT343
 Status RoHS: Lead percuma / RoHS Compliant
 Helaian data: [SGA-8343Z.pdf](#)













Pengilang / jenama: RFMD
 Kapal Dari: Hong Kong
 Cara Penghantaran: DHL/Fedex/TNT/UPS/EMS

 **HANTAR PERTANYAAN** >

Maklumat produk

Nombor Bahagian	SGA-8343Z	Pengeluar	RFMD
Penerangan	IC RF AMP PCS 0HZ-6GHZ SOT343	Status Status Percuma / Rosh Status	Lead percuma / RoHS Compliant
Lembaran data	SGA-8343Z.pdf		
Voltan - Bekalan	4V	Kekerapan ujian	1.95GHz
Pembekal Peranti Pakej	SOT-343	Siri	-
Jenis RF	PCS, RFID, 3G	pembungkusan	Tape & Reel (TR)
Pakej / Kes	SC-82A, SOT-343	P1dB	7.5dBm ~ 9dBm
Nama lain	599-1055-2 SGA8343Z	Noise Rajah	1.4dB ~ 1.75dB
Tahap Sensitiviti Lembapan (MSL)	1 (Unlimited)	Status Status Percuma / Rosh Status	Lead free / RoHS Compliant
Gain	17.5dB	kekerapan	0Hz ~ 6GHz
Penerangan terperinci	RF Amplifier IC PCS, RFID, 3G 0Hz ~ 6GHz SOT-343	Semasa - Bekalan	50mA

Produk Berkaitan

 <p>SGA-6586Z Pengilang: RFMD Penerangan: IC AMP HBT SIGE 4000MHZ SOT-86 RFQ</p>	 <p>SGA-9289 Pengilang: RFMD Penerangan: IC RF AMP WLL 0HZ-3GHZ SOT89-3 Muat turun: SGA-9289.pdf RFQ</p>
 <p>SGA-9289Z Pengilang: RFMD Penerangan: IC AMP HBT SIGE 3GHZ SOT-89 Muat turun: SGA-9289Z.pdf RFQ</p>	 <p>SGA-7489 Pengilang: RFMD Penerangan: IC RF AMP GP 0HZ-3GHZ SOT89-3 Muat turun: SGA-7489.pdf RFQ</p>
 <p>SGA-9189 Pengilang: RFMD Penerangan: IC RF AMP WLL 0HZ-3GHZ SOT89-3 RFQ</p>	 <p>SGA-9189Z Pengilang: RFMD Penerangan: IC AMP HBT SIGE 3GHZ SOT-89 RFQ</p>
 <p>SGA-8343 Pengilang: RFMD Penerangan: IC RF AMP PCS 0HZ-6GHZ SOT343 Muat turun: SGA-8343.pdf RFQ</p>	 <p>SGA-6589 Pengilang: RFMD Penerangan: IC AMP CELLULAR 0HZ-3.5GHZ SOT89 Muat turun: SGA-6589.pdf RFQ</p>
 <p>SGA-7489Z Pengilang: RFMD Penerangan: IC AMP HBT SIGE 3000MHZ SOT-89 RFQ</p>	 <p>SGA12E05-USB Pengilang: MEAN WELL Penerangan: AC/DC WALL MOUNT ADAPTER 5V 12W RFQ</p>
 <p>SGA-6589Z Pengilang: RFMD Penerangan: IC AMP HBT SIGE 3500MHZ SOT-89 RFQ</p>	 <p>SGA12E05-P1J Pengilang: MEAN WELL Penerangan: AC/DC WALL MOUNT ADAPTER 5V 12W RFQ</p>

Tag berkaitan

RFMD SGA-8343Z
 Harga SGA-8343Z
 Lembaran Data PDF SGA-8343Z
 Saham SGA-8343Z
 RFMD SGA-8343Z
 RFMD SGA-8343Z

Pengedar SGA-8343Z
 Gambar SGA-8343Z
 Lembaran Data Muat turun SGA-8343Z
 Beli SGA-8343Z
 Pembekal RFMD

Pembekal SGA-8343Z
 Gambar SGA-8343Z
 Lembaran Data SGA-8343Z
 Beli RFMD SGA-8343Z
 Pengedar RFMD