



Inventek Systems
Embedding Connectivity Everywhere

Inventek Systems

GPS Module

ISM480F1

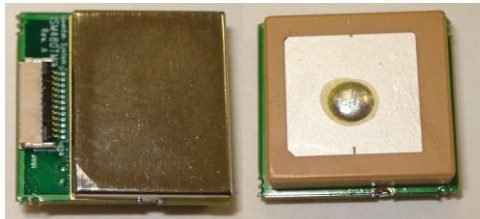

Table of Contents

1	GENERAL DESCRIPTION.....	3
2	PART NUMBER DETAIL DESCRIPTION.....	3
	Ordering Information	3
3	GENERAL FEATURES.....	3
3.1	Improved Jamming Mitigation	4
4	COMPLIMENTARY DOCUMENTATION	4
4.1	Inventek Systems	4
4.2	SiRF Technology	4
5	SPECIFICATIONS.....	5
5.1	General.....	5
5.2	Module Architecture	5
5.3	Hardware Features	6
5.4	Mechanical Specifications	6
5.5	Environmental Specifications	6
6	PERFORMANCE.....	6
6.1	Position and Velocity.....	6
6.2	Time To First Fix ^(See Note 2) (TTFF)	7
6.3	Dynamic Constraints.....	7
6.4	Receiver Sensitivity	7
7	HARDWARE ELECTRICAL SPECIFICATIONS	9
7.1	Power Supply Maximum Ratings	9
7.2	Specifications.....	9
7.2.1	Electrical Specification	9
7.2.2	Mechanical Specification.....	10
7.2.3	Pin Positions.....	10
7.2.4	Detailed Pin Description.....	12
8	BASIC OPERATION (SPI or UART)	13
8.1	NMEA input and output messages	14
8.2	SiRF OSP Protocol	14
8.3	Antenna.....	15
	Antenna Patch specifications –Inventek PAT154 (ISM480 Ground plane).....	15
8.4	Return Loss	15
8.5	Impedance – Smith Chart.....	16
8.6	Gain Pattern (Unit: dBic).....	17
8.7	Return Loss and Impedance.....	17
8.8	Axial Ratio.....	19
9	Product Compliance Considerations.....	19
10	ORDERING INFORMATION.....	19
11	REVISION CONTROL.....	20
12	CONTACT INFORMATION.....	20

1 GENERAL DESCRIPTION

The [Inventek](#) ISM480F1 is a 48 channel global positioning system (GPS) receiver with an integrated 15x15x4 mm ceramic patch antenna with high sensitivity, high gain, and low power. The small form factor GPS receiver is based on the fast and deep GPS signal search capabilities of CSR, SiRFstar IV™ architecture.

Several key features about this module are:

- ✚ The module is capable of generating and storing extended ephemeris data to an external device for much faster hot starts in weak signal environments.
- ✚ Built-in jamming detection and mitigation to permit fast and accurate navigation solutions in high noise environments.
- ✚ Default output is SPI (Slave).
- ✚ An addition 4 dB in tracking sensitivity and 4 dB navigation sensitivity over the world class SiRFstar III devices.

2 PART NUMBER DETAIL DESCRIPTION

Ordering Information

Device	Description	Ordering Number
ISM480F1	GPS Module, Commercial Temp., Standard Firmware	ISM480F1-C4.1
ISM480F1	GPS Module, Commercial Temp, with 9600 baud NEMA Firmware	ISM480F1-C5.V0006
ISM480EVB	GPS Evaluation board, with ISM480F1-C4.1, Cable, Logging, Display	ISM480EVB

3 GENERAL FEATURES

- Based on the high performance features of the SiRFstar IV, GSD4e-9411 processor.
- Compact module size for easy integration: 16.5x 16.5 x 7 mm (shield height included).
- Host UART or SPI or I²C interface (Default SPI)
- 48 track verification channels
- Custom output Firmware can be provided
- Integrated LNA, SAW Filter, TCXO and RTC
- Single power supply voltage 1.8V.
- Lead Free Design which is compliant with ROHS requirements
- Cold, Warm, Hot Start Time: 35, 35, 1 Sec. respectively.
- Reacquisition Time: 1 second.
- Programmable

3.1 Improved Jamming Mitigation

- ✦ Better identification and dismissal of jamming signals through enhanced Carrier Wave (CW) detection.
- ✦ Removes in-band jammers up to 80 dB-Hz
- ✦ Tracks up to 8 CW jammers
- ✦ Enhanced development tools to identify noise issues for troubleshooting potential system level noise issues

4 COMPLIMENTARY DOCUMENTATION

4.1 Inventek Systems

Inventek Test Report

ISM480EVB- Board Specification

4.2 SiRF Technology

NMEA Reference Manual (www.Inventeksys.com) under specifications.

SiRF Binary Protocol Reference Manual

OSP Reference Manual

Sirf Live Software

5 SPECIFICATIONS

5.1 General

5.2 Module Architecture

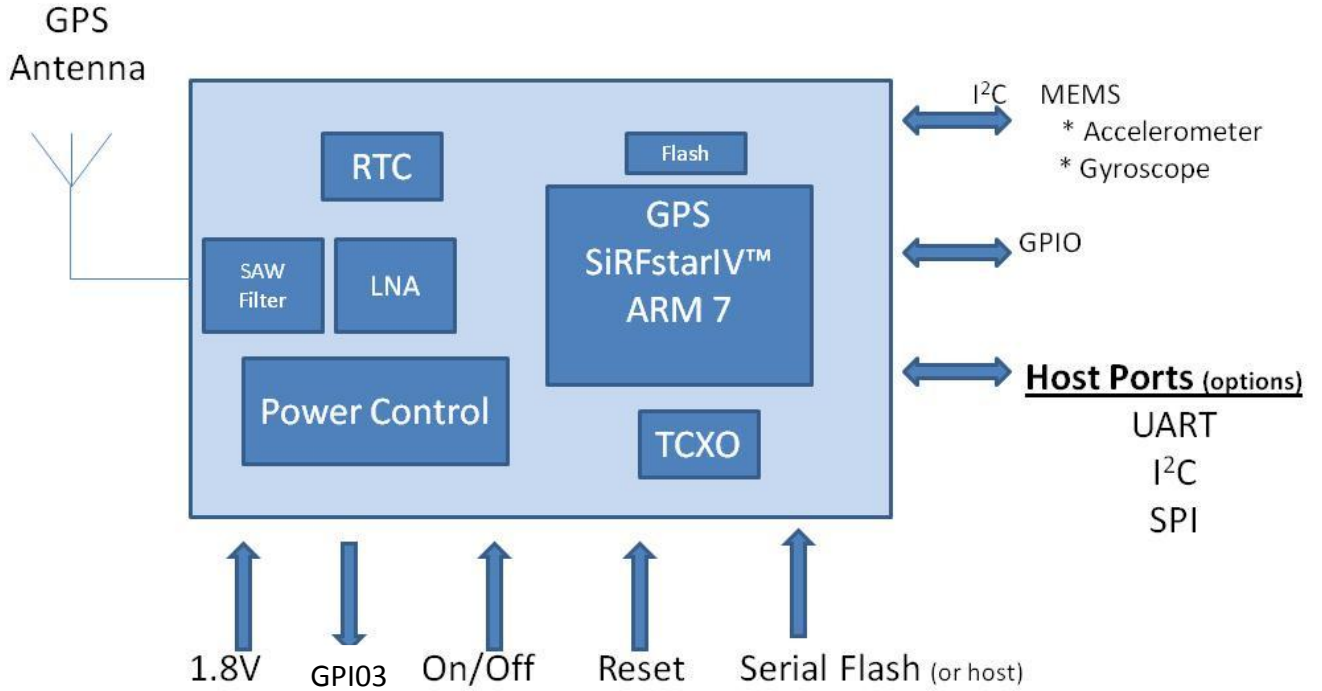

Figure 1 Inventek's ISM480F1 General Block Diagram

5.3 Hardware Features

The ISM480F1 is a complete navigation GPS processor built on a low power SiRF IV GSD4e processor. The module has an ARM7 processor and RF front end with integrated LAN and SAW to complete a standalone or Aided-GPS engine.

5.4 Mechanical Specifications

The Physical dimensions of this GPS Module are as follow

Items	Description
Length	16.5 (-/+0.2 mm)
Width	16.5 (-/+0.2 mm)
Height	7.0 ± 0.2 mm
Connector	12 Pin IPEX P/N 20488-012e-01

5.5 Environmental Specifications

Item	Description
Operating temperature range	-35 deg. C to +80 deg. C
Storage temperature range	-55 deg. C to +100 deg. C
Humidity	95% max non-condensing
Altitude	18,000m (60,000 ft) max.
Velocity/Speed	515 m/Sec (1000 knots) max.
Jerk	20 m/Sec ³ (max)
Acceleration	4 G (max)

6 PERFORMANCE

6.1 Position and Velocity

Parameter	Description
Position	10m, 2D RMS Autonomous, and 5m 2D RMS, SBAS corrected.
Velocity	0.1 m/Sec
Time	1 uSec synchronized to GPS time

2D RMS (Root Mean Square) describes the position accuracy at approximately 95 percent of the data points occur with this distance of a know truth.

6.2 Time To First Fix ^(See Note 2) (TTFF)

Mode	ISM480 Module
TTFF Hot (valid almanac, position, time & ephemeris)	1 s
TTFF Warm (valid almanac, position, & time)	<35 s
TTFF Cold (valid almanac)	<35 s
Re-Acquisition (<10 secs obstruction with valid almanac, position, time & ephemeris)	100 ms

Note 2: Open Sky and Stationary Environments

6.3 Dynamic Constraints

Parameter	Description
Altitude	18,000 m (60,000 ft) max.
Velocity	515 m/Sec (1000 knots) max.
Acceleration	4 G max
Jerk	20 m/Sec ³ max

6.4 Receiver Sensitivity

Test No.	Test Description	Measured Results	Comments
1	SENSITIVITY (ACQUISITION)		
1.1	Minimum Satellite Acquisition Signal Level Record Minimum Acquisition RF input level and C/No	12dBHz @ -158dBm	Set signal level to -142dBm at receiver RF input. Initial Acquisition.
2	SENSITIVITY (TRACKING)		See Note 1
2.1	Strong Signal Sensitivity Level Record RF input level @ C/No of 40dB-Hz. Verify Fast Acquisition	40dBHz @ -132dbm	Set signal level to -130dBm at receiver RF input. Once acquired, and then test for tracking sensitivity.
2.2	Normal Signal Sensitivity Level Record RF input level @ C/No of 34dB-Hz .	34dBHz @ -138dBm	Set signal level to -136dBm at receiver RF input.

2.3	Minimum Signal Tracking Level Record Minimum Tracking level RF input level and C/No	9dBHz @ -162dBm	Record minimum level at which valid tracking (Valid Navigation) is maintained
3	ACQUISITION / TTFF	<i>(Record Logfile)</i>	See Note 2
3.1	Hot Start TTFF (Ave of >20 measurements) Nominal Signal Level	0.5s	Measure Ave. TTFF of all trials @-140dBm
3.2	Hot Start TTFF (Ave of >20 measurements) Low Signal Level	1.8s	Measure Ave. TTFF of all trials @-146dBm
3.3	Warm Start TTFF (Ave of >20 measurements) Weak Signal Level	6s	Measure Ave. TTFF of all trials @-146dBm
3.4	Cold Start TTFF <u>Autonomous</u> (Ave of >20 measurements)	26s	Measure Ave. TTFF of all trials @-136dBm
3.5	Reacquisition 1min ON/1min OFF (Avg. of >20 measurements)	1.0s	Rx must reacq all attempts @- 136dBm
4	FULL POWER STATIONARY	<i>(Record Logfile)</i>	See Note 3
4.1	Number of Samples/3D Navigation (2 hrs min)	18891	1 second sampling with 100% 3D Nav
4.2	Horizontal Position Accuracy (Max.)	3.69m	Horizontal Trajectory Plot
4.3	Horizontal Position Accuracy (Ave.)	1.31m	Same as 4.1
4.4	Vertical Position Accuracy (Max.)	3.2m	Vertical Variation Plot
4.5	Vertical Position Accuracy (Ave.)	0.8m	Same as 4.3
4.6	Horizontal Velocity Accuracy (Max Dev.)	0.1m/s	Horizontal Velocity Plot
4.7	Vertical Velocity Accuracy (Max Dev.)	0.7m/s	Vertical Velocity Plot

Notes:

1. All RF performance requirements for Section 2 are performed with a simulator and are as compared to a reference design.
2. Acquisition/TTFF measurements are open sky rooftop antenna.
3. Stationary at nominal signal level (-130dBm), open sky or simulator.
4. All tests are to be performed at ambient temperature.

7 HARDWARE ELECTRICAL SPECIFICATIONS

7.1 Power Supply Maximum Ratings

Parameter	ISM480F1 Module
Input voltage	1.8 VDC
Current (avg) at full power (1.8V)	45 mA
Battery backup voltage	1.8 VDC
Hibernate	20 μ A
KA State	10 μ A

In rush current of approx. 55 mA on startup

7.2 Specifications

7.2.1 Electrical Specification

DC Characteristics

Parameter	Symbol	Mode	Min	Typ	Max	Units
Input Voltage	V in	1.71	1.71	1.8	1.89	V
Power supply Current	Icc	Acquisition		45		mA
		Tracking		37		mA
		Hibernate PTF		10		μ A
Input Voltage high	GPIO				3.5	V
Input Voltage Low					.5	V
Input capacitance				5		pF
Input Leakage Current		V in = 1.8V or 0V	-10		10	μ A
Input Leakage Current		V in = 1.8V or 0V	-10		10	μ A

7.2.2 Mechanical Specification

Dimensions	16.01 x 12.09 x 7.52 mm
Connector	12 position Mini Flex 0.5mm single - Ipex -20488-012E-01
Weight	7 ounces
Interconnect Cable	R12 - 12 strand Ribbon cables

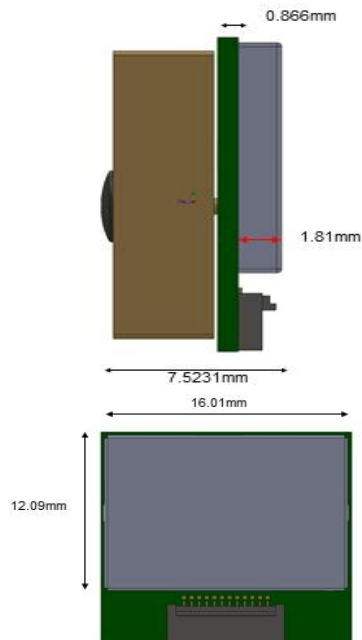

7.2.3 Pin Positions

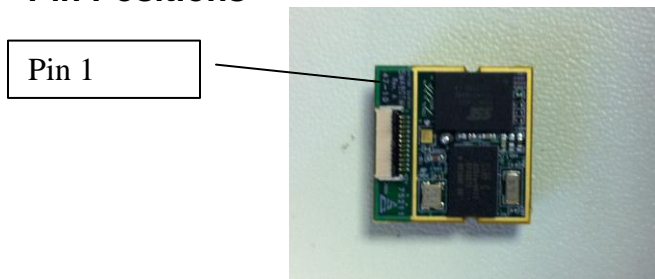

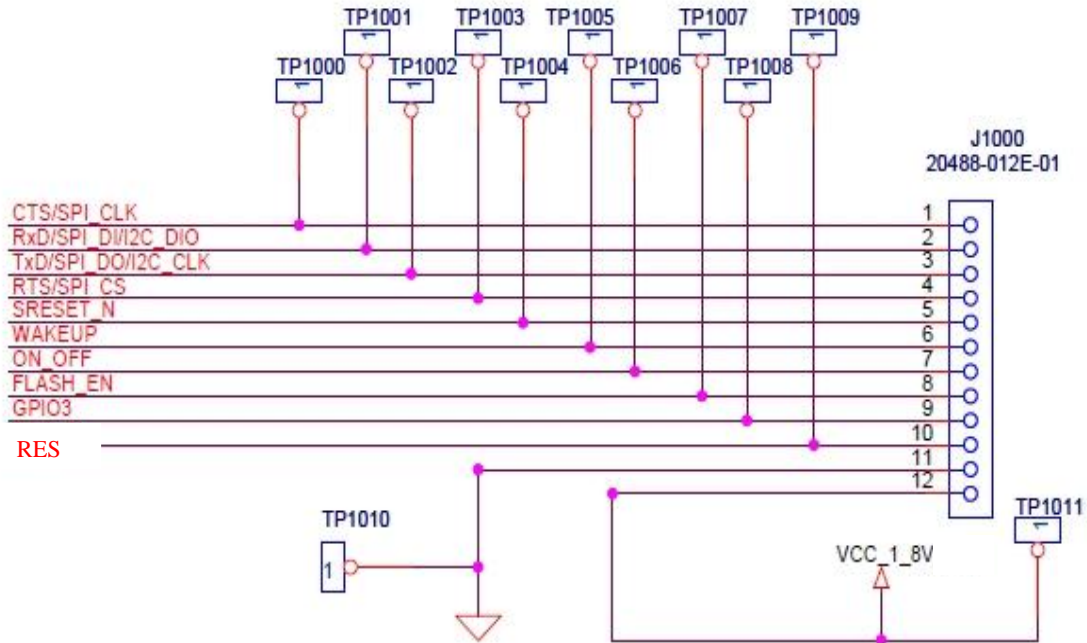

Pin No.	Type	Pin Definition	Descriptions
1	O	CTS/SPI_Clk/Mode	SPI Clk/ Mode selection
2	I/O	RX/MOSI/SDA	SSPI_DI slave SPI data input (MOSI) UART_RX UART data receive (RX) I2C_DIO I ² C bus data (SDA)
3	I/O	TX/MISO/SCL	SSPI_DO slave SPI data output (MISO) UART_TX UART data transmit (TX) I2C_CLK I ² C bus clock (SCL)
4	I/O	SPI CS/RTS/GPIO7	SPI CS, RTS, GPIO -7
5	I	Reset#	System Reset
6	O	Wakeup	Power control pin (Output – High GPS on)
7	I	On /Off	Pulse High (momentary) to turn on
8	I	Flash Enable	Strap High (1.8V) to put in Flash Mode
9	O	GPIO 3	Message ready (SPI)
10	I	RES	Reserved
11	Gnd	Ground	Gnd
12	Vcc	Vcc	1.8 V dc

7.2.4 Detailed Pin Description

Pin 1: CLK CTS (GPIO 6) - See Section 8

Pin 2: Rx/ MOSI/SDA – The function of these pins are defined upon power per section 8

- SPI – MOSI
- UART – RX
- I²C – SDA

Pin 3: TX/MISO/SCL – The function of these pins are defined upon power per section 8

- SPI – MISO
- UART – TX
- I²C – SCL

Pin 4: RTS, SPI_CS, GPIO7- See Section 8

Pin 6: Wakeup:

This is an output that indicates the state of the GPS. Low is hibernate and high is active. You should monitor Wake-up to know the state of the GPS

Pin 7: On/OFF

The input level is 1.8V level direct hardware connection to the internal Finite State Machine. The RTC clock must be on and state for this control to be functional. Minimum on pulse duration is two RTC ticks, about 63us. Minimum inter-pulse interval is one second. Minimum off duration is two RTC ticks, about 63us. See Figure below give a guideline for pulse waveform. A critical item to avoid is contact bounce if a mechanical switch is used. If you are using a mechanical switch, we recommend a 150KΩ pull down resistor.

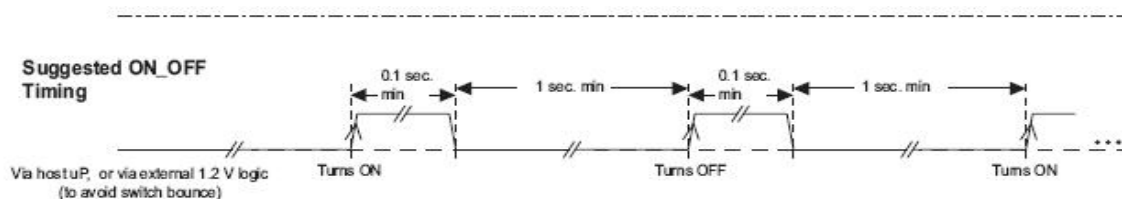

Pin 8: Flash Enable – Pull High to Flash, unconnected for normal operation

Pin 9: Message Ready – When in SPI mode, PIN will go High to indicate a message is ready to be read.

Pin 11: GND

Pin 12: 1.8 V - **Maximum input ripple is as follows:

0-3Mhz	50 mV
>3 Mhz	15mV

** Additional filtering and decoupling must be added to your power supply circuit to reduce levels to less than the stated amount.

8 BASIC OPERATION (SPI or UART)

The ISM480F1 has three outputs to the host, SPI, I²C and UART. All ports are multiplexed on a shared set of pins. At system reset, the host port pins are disabled, so no conflict occurs.

At system reset, you can boot strap the device as follows:

Port Type	Pin 1 (GPIO 6)	Pin 4 (GPIO 7)
UART	External pullup10KΩ	(N/C) Do not connect
SPI (Default)	(N/C) Do not connect	(N/C) Do not connect
I2C	(N/C) Do not connect	Add a 10KΩ pull down

The host ports are configured based on these straps. The software sets up the port pins requirements during low power modes.

UART Mode

Port Type	Pin 1	Pin 4
UART Mode	External pullup10KΩ	(N/C) Do not connect

The ISM480F1 will output NMEA-0183, 4800 baud, 8-N-1. The transmit and receive channel contain a 64B FIFO.

- TX is GPS output
- RX used for GPS control
- nCTS and nRTS are optionally used for hardware flow control.

Through this UART connection, your host microcontroller can change the baud rate, change the output to OSP (SiRF Binary) or enable or disable many features of the ISM480F1. Outputs are LVCMOS 1.8V compatible.

SPI Mode

On initial power on, the GPS module will look at pin 1 and Pin 4 to determine the mode of operation. Your SPI bus should have no pull up or pull down is required. On power up the connection to Pin 1 and Pin 1 must be tri stated on the SPI bus.

Port Type	Pin 1	Pin 4
SPI Mode	(N/C) Do not connect	(N/C) Do not connect

The host interface SPI is a slave mode SPI.

- MOSI,MISO,nCS and SCLK
- Transmit and Receive have independent 1024B FIFO buffers.
- An interrupt is provided when the transmit FIFO and output serial register are both empty.
- The transmit and receive have individual software defined 2-byte idle patterns of 0xa7 0xb4.
- Max clock of 6.8Mhz

I²C Mode

Port Type	Pin 1	Pin 4
I ² C Mode	(N/C) Do not connect	Add a 10KΩ pull down

The host interface I²C mode.

- Operation up to 400kbps.
- Transmit and Receive have independent FIFO length of 64 bytes.
- The default address is
 - RC: 0x60
 - TX: 0x62
- Multi-master I²C mode is default mode

8.1 NMEA input and output messages

A complete description of each message is contained in the SiRF NMEA reference manual.

8.2 SiRF OSP Protocol

A complete description of each binary message is contained in the SiRF OSP Protocol reference manual.

8.3 Antenna

Antenna Patch specifications –Inventek PAT154 (ISM480 Ground plane)

The definition of the measured planes:

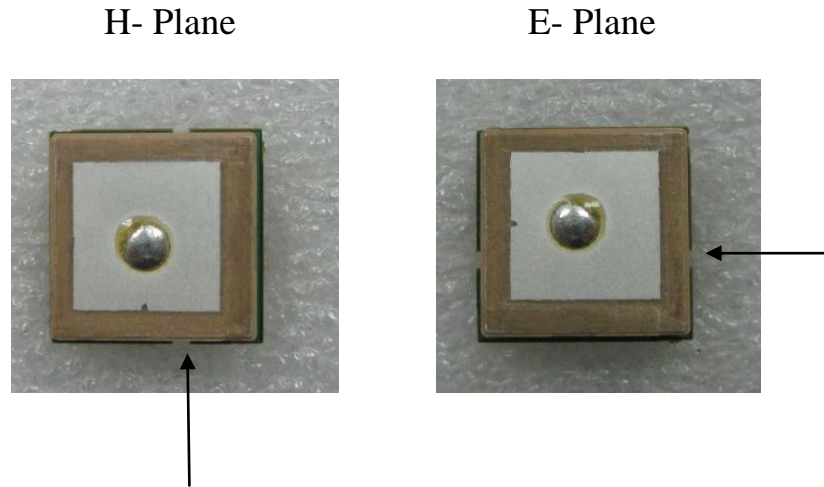

8.4 Return Loss

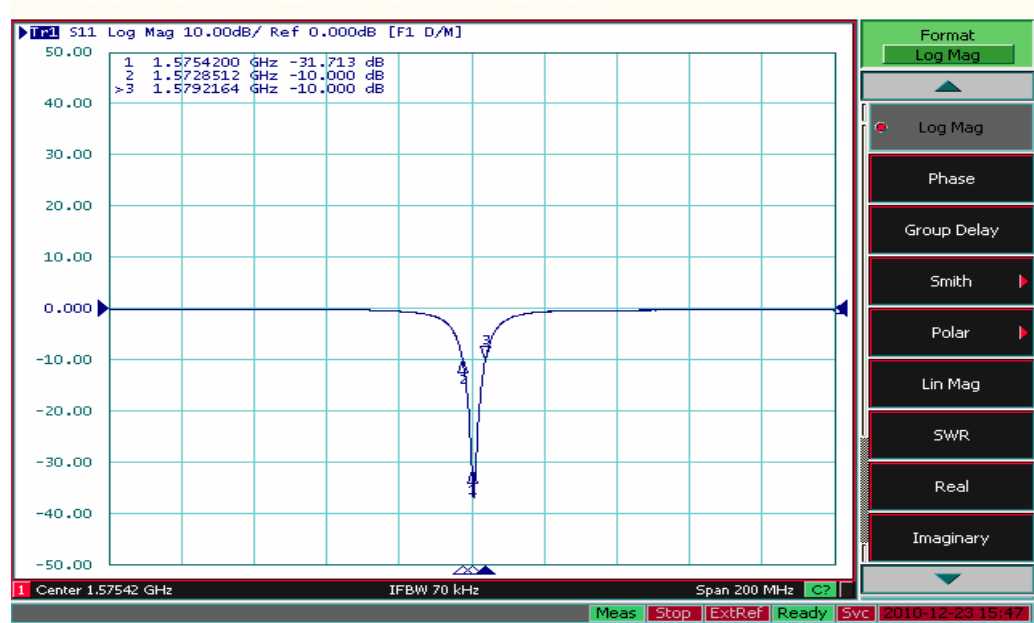

8.5 Impedance – Smith Chart

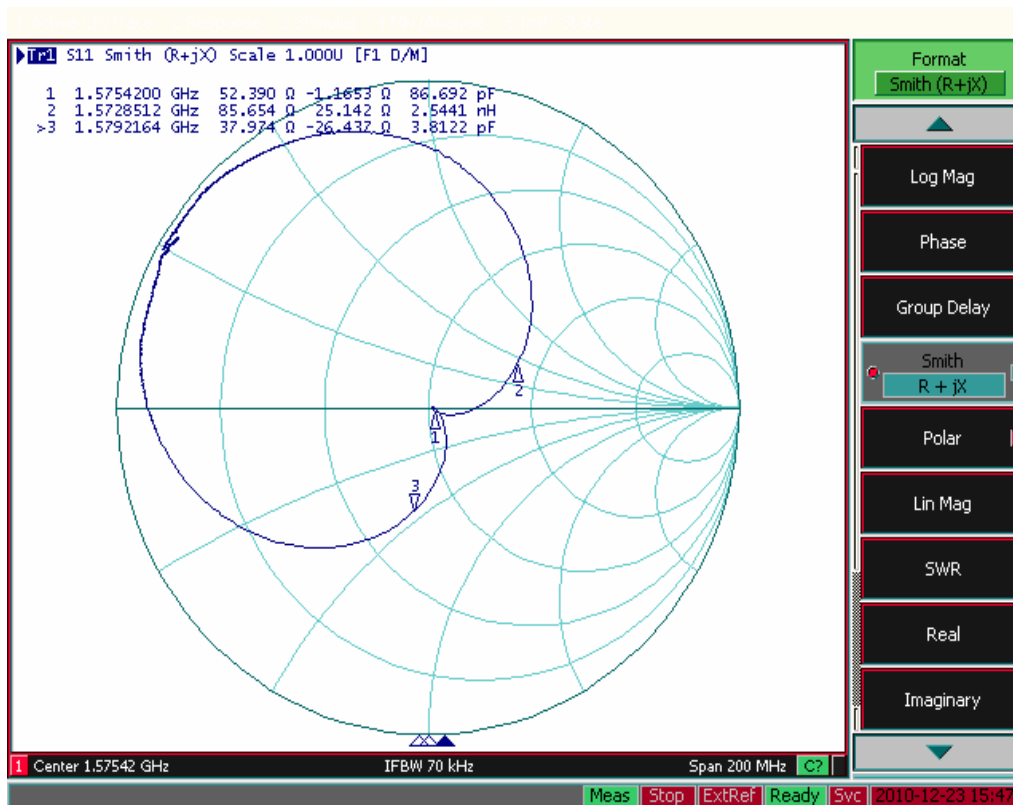

8.6 Gain Pattern (Unit: dBic)

Far-field amplitude of h.nsi

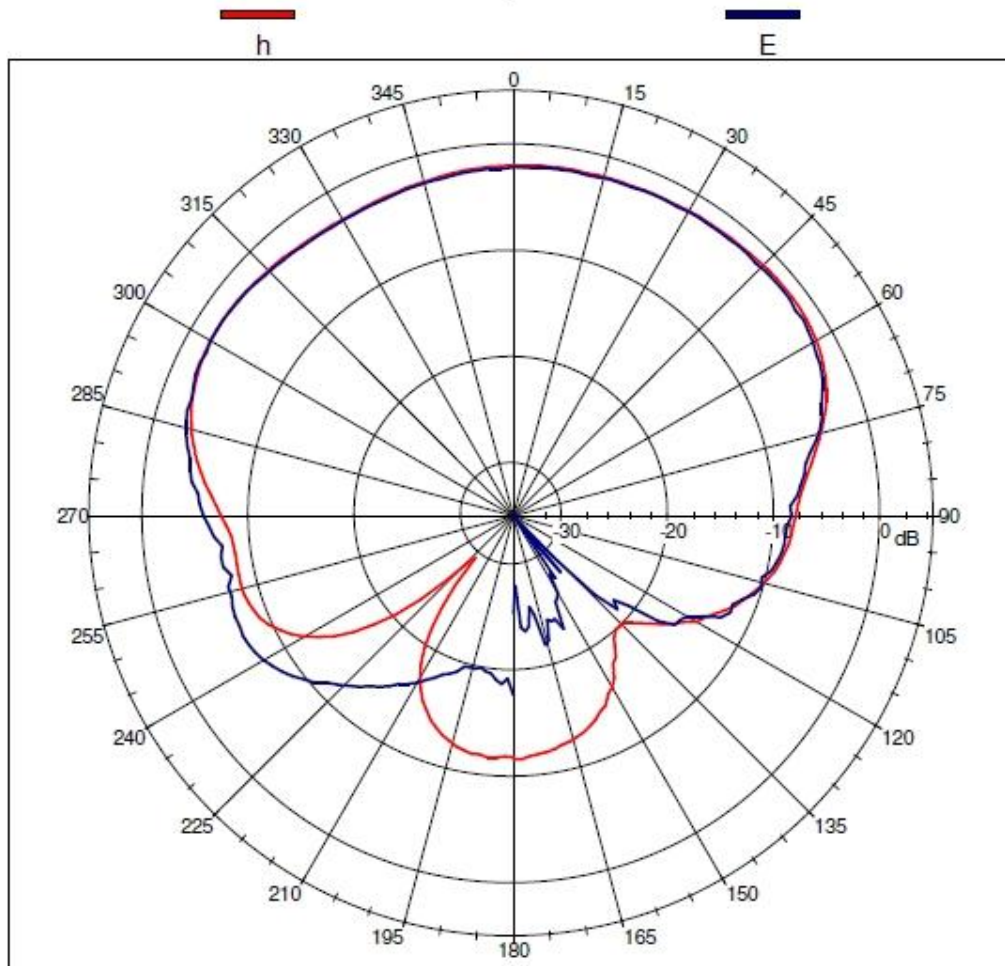

8.7 Return Loss and Impedance

Dimension(mm)	Return Loss	Impedance	Gain 0° H-Plane(dBic)
15 x 15 x 4	-31.7	52.3 - j 1.1	-2.05

Gain Pattern Data (dBic)

Angle	H	E
-90	-7.50	-5.85
-76	-3.81	-3.25
-60	-2.13	-2.07
-46	-2.37	-2.49
-30	-2.85	-2.92
-16	-2.51	-2.66
0	-2.05	-2.23
16	-2.02	-2.10
30	-1.94	-1.99
46	-1.67	-1.94
60	-2.05	-2.41
76	-5.33	-5.56
90	-8.41	-8.80

Axial Ratio Data (dB)

Angle	H	E
-90	-7.50	-5.85
-76	-3.81	-3.25
-60	-2.13	-2.07
-46	-2.37	-2.49
-30	-2.85	-2.92
-16	-2.51	-2.66
0	-2.05	-2.23
16	-2.02	-2.10
30	-1.94	-1.99
46	-1.67	-1.94
60	-2.05	-2.41
76	-5.33	-5.56
90	-8.41	-8.80

8.8 Axial Ratio

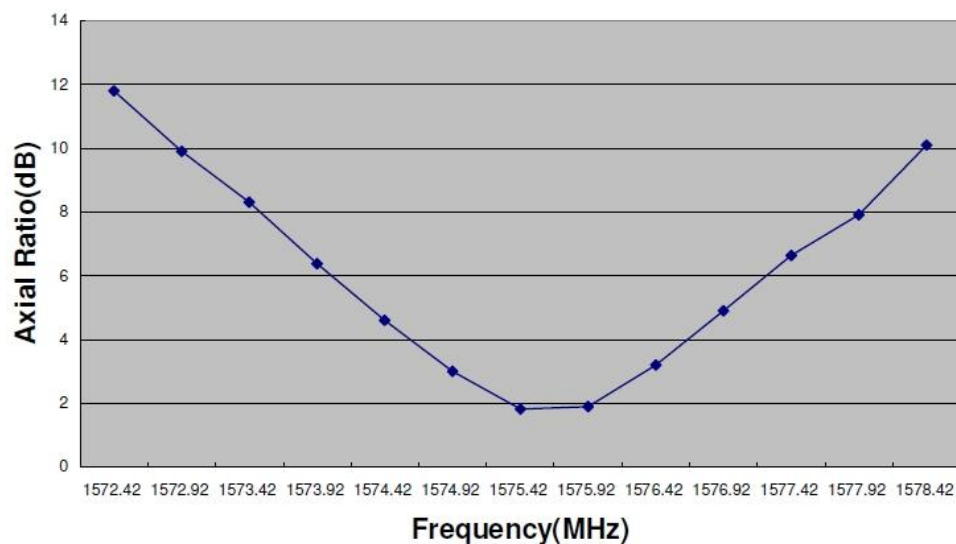

9 Product Compliance Considerations

RoHS: Restriction of Hazardous Substances (RoHS) directive has come into force since 1st July 2006 all electronic products sold in the EU must be free of hazardous materials, such as lead. Inventek is fully committed to being one of the first to introduce lead-free GPS products while maintaining backwards compatibility and focusing on a continuously high level of product and manufacturing quality.

10 ORDERING INFORMATION

Part number	Description	Type	Temperature
ISM480F1-C4.1	GPS module	Standard build	-35C- 80 °C
ISM480F1-C5.6	GPS Mode	NMEA - 9600 Baud default Firmware	-35C- 80 °C
ISM480EVB	Evaluation Board	NMEA – 4800	

11 REVISION CONTROL

Document : ISM480F1	GPS module
External release	DOC-DS-20002-1.2

Date	Author	Revision	Comment
3/28/2011	FMT	1.0	Preliminary
7/19/2011	MT	1.1	Typo on SPI mode
2/3/2012	FMT	1.2	1PPS changed to GPIO3, logo change

12 CONTACT INFORMATION

Inventek Systems
2 Republic Road
Billerica Ma, 01862
Tel: 978-667-1962
Sales@inventeksys.com

www.inventeksys.com

Inventek Systems reserves the right to make changes without further notice to any products or data herein to improve reliability, function, or design. The information contained within is believed to be accurate and reliable. However Inventek Systems does not assume any liability arising out of the application or use of this information, nor the application or use of any product or circuit described herein, neither does it convey any license under its patent rights nor the rights of others.