

REVISIONS			
LTR	DESCRIPTION	DATE	APPROVED
—	INITIAL RELEASE		H D

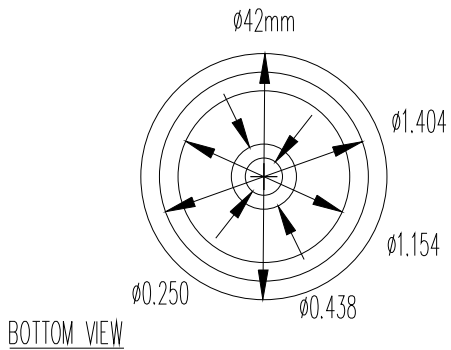
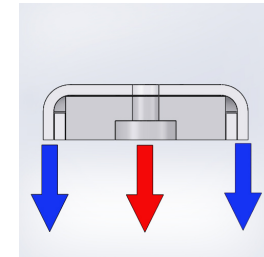
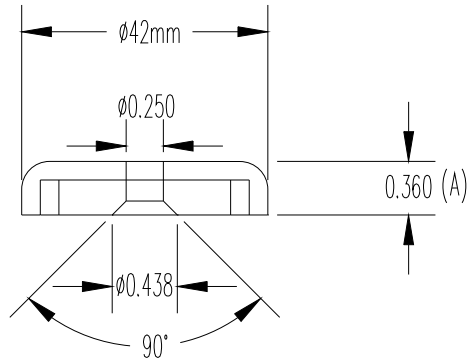
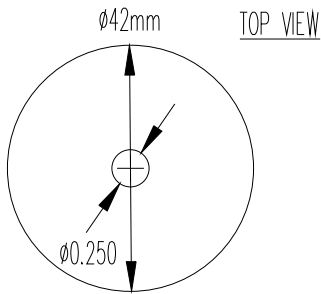

UNLESS OTHERWISE SPECIFIED DIMENSIONS ARE IN INCHES	
TOLERANCES:	
FRACTIONS:	$\pm 1/64$
DECIMALS:	± 0.015
ANGLES:	$\pm 1^\circ$
MATERIAL:	NdFeB
FINISH:	NiCuNi

RADIAL MAGNETS INC.				
108B NW 20th St. BOCA RATON, FL 33431 (561)392-2103				
SHAPE	STRENGTH	PLATING	SIZE AND DIRECTION OF MAGNETIZATION (A)	
POT	N35	NiCuNi	POT A42	↑
SIZE A	PART # 8340	DRAWING # RM8340	REVISION -	
SCALE 1 : 1	DRAWN: CG	CHECKED: HD	APPROVED: HD	PAGE 1 OF 1