

GPS RADIONOVA® RF Antenna Module

Part No. M10214-A

Product Specification

Applications

- PNDs
- Portable handheld battery operated GPS enabled devices
- PDAs
- Multi-mode mobile phones
- Smart phones

Features

- Low cost single package GPS RF antenna module
- SiRF Star III GPS Chipset Architecture
- Low current consumption
- Easy to use 'drop-in solution'
- Built in filter allows co-existence with GSM / CDMA / UMTS / WLAN / BT
- Resistant to de-tuning

Product Description

GPS RADIONOVA M10214-A is a ROM based, highly integrated GPS RF Antenna Module suitable for L1-band GPS and A-GPS systems. The device is based on the high performance SiRF Star III GPS architecture combined with Antenna's high efficiency antenna technology.

All front-end components are contained in a single package laminate base module for optimum performance. M10214-A operates on a single 3.6V positive bias supply with low power consumption and available low power modes for further power savings.

M10214-A is supported by SiRF stand alone software and uses a UART as the host processor interface.

Functional Block Diagram

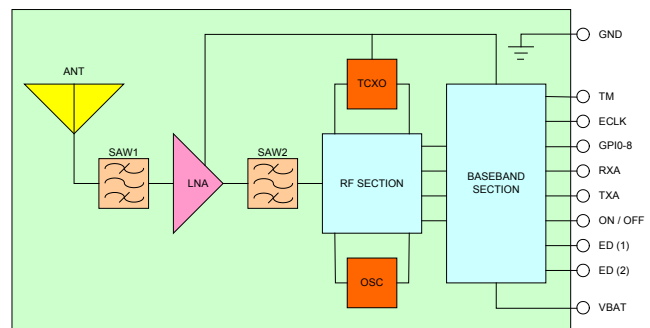

Package Style

43 x 9 x 4mm RF Antenna Module

Top View (without shielding can)



Bottom View



Typical Mount (side view)

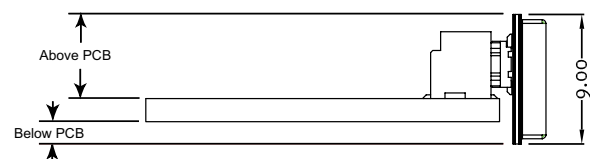

Absolute Maximum Ratings

Symbol	Parameter	Min	Max	Unit
Vdd	Supply Voltage		5.5	V
RFin	RF Input Power		10	dBm
ESD	Electrostatic Discharge Immunity (HBM)		TBD	kV
T _{STG}	Storage Temperature	-40	150	°C

*Exposure to absolute ratings may adversely affect reliability and may cause permanent damage.

Recommended Operating Conditions

Symbol	Parameter	Typ	Unit
Ta	Ambient Temperature	25	°C
Vbat	Main Supply Voltage	3.6	V
Fref	Reference Frequency	16.369	MHz

DC Electrical Characteristics

Conditions: Vbat = 3.6V, Ta = 25 °C

Symbol	Parameter	Typ	Unit
I _{CC} _{ACQ}	Total Supply Current (Acquisition Mode)	45	mA
I _{CC} _{TRK}	Track Mode	27	mA
I _{CC} _(CLK)	Clock Only	10	mA
I _{CC} _(STAND BY)	Stand By Mode	6	mA
I _{CC} _(HIBERNATE)	Hibernate Mode	13	µA

Performance Specification

Conditions: Vbat = 3.6V, Ta = 25 °C

Symbol	Parameter	Typ	Unit
	Power Consumption		
	Acquisition Mode	75	mW
	Tracking Mode	50	mW
	Trickle Power	25	mW
G _{LNA}	LNA Gain	20	dB
NF _{SYS}	Overall Radio Noise Figure	TBD	dB
P _{1dB}	1dB Compression Point	-65	dBm
ANT _{RL}	Antenna Return Loss	-12	dB
ANT _{EFF}	Antenna Efficiency	50	%

Band Rejection

Frequency	Standard	Typ	Unit
824-849	Cellular CDMA	89	dBc
869-894	GSM850	89	dBc
880-915	GSM900	89	dBc
1710-1785	DCS (LSB)	74	dBc
1850-1910	PCS	84	dBc
1920-1980	WCDMA	84	dBc
2400	WLAN, BT and WiMAX	80	dBc

System Performance

Parameter	Specification
Data Output	UART
TCXO Reference	16.369MHz (0.5ppm)
Position Accuracy	2.5m
Sensitivity	
Acquisition	-142dBm
Tracking	-159dBm
TTF	
Hot Start	<1s
Warm Start	<35s
Cold Start	<35s

Pin out Description

Pin	Name	Description
1	TM	OUTPUT - Time Mark (Handset application, otherwise tie to GND)
2	GND	Ground connection
3	GND	Ground connection
4	GND	Ground connection
5	GND	Ground connection
6	GND	Ground connection
7	GND	Ground connection
8	GND	Ground connection
9	ECLK	INPUT - External clock for Frequency Aiding (Handset application, otherwise tie to GND)
10	GPIO-8	INPUT - Time Aiding (Handset application, otherwise tie to GND)
11	RXA	SERIAL INPUT - UART Receive Input (Main message connection to host CPU)
12	TXA	SERIAL OUTPUT - UART Transmit Output (Main message connection to host CPU)
13	ON / OFF	INPUT - Power ON/OFF control line. Momentary high pulse to turn on and off the device. Pulse duration >70µs with minimum inter-pulse interval of 1s
14	VBAT	POWER SUPPLY (3.6V)
15	ED (1)	INPUT - Memory Boot mode Configuration. External Bus Signal #1 (See table below)
16	ED (0)	INPUT - Memory Boot mode Configuration. External Bus Signal #0 (See table below)

Program Memory Bootstrap Selection		
	ED (1)	ED (0)
Flash Mode	0	0
Reserved	0	1
Flash Loader Mode	1	1
ROM Mode (default)	1	0

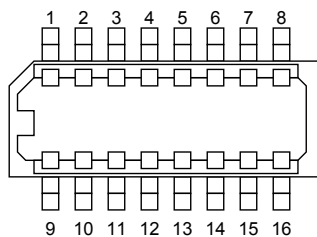

Mechanical Drawing

Top View (Mounted)

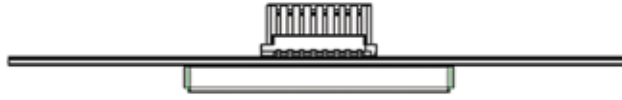

Front View (Component Side)

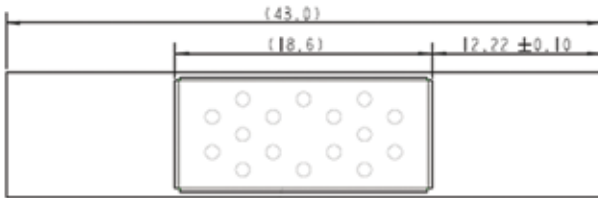

Side View

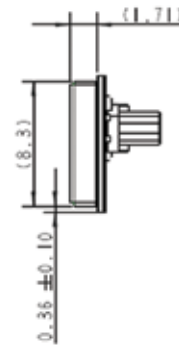

Back View (Connector Side)

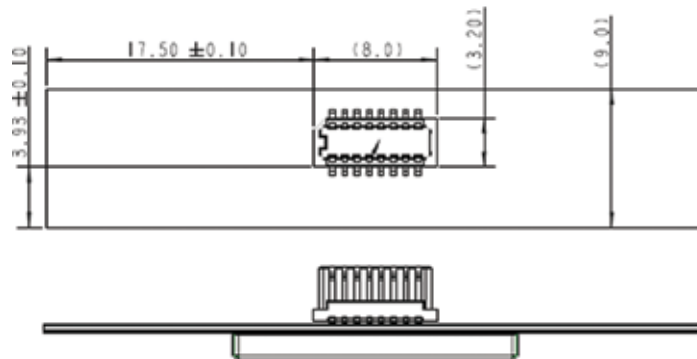

Typical Mount (side view)

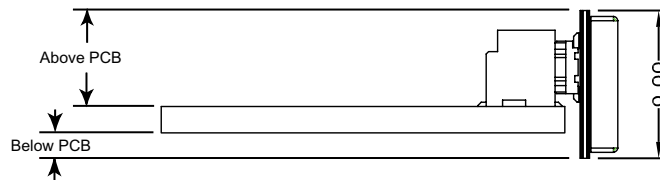

Notes: Units = mm

Antenna Performance

RHCP realized Gain (dBi)

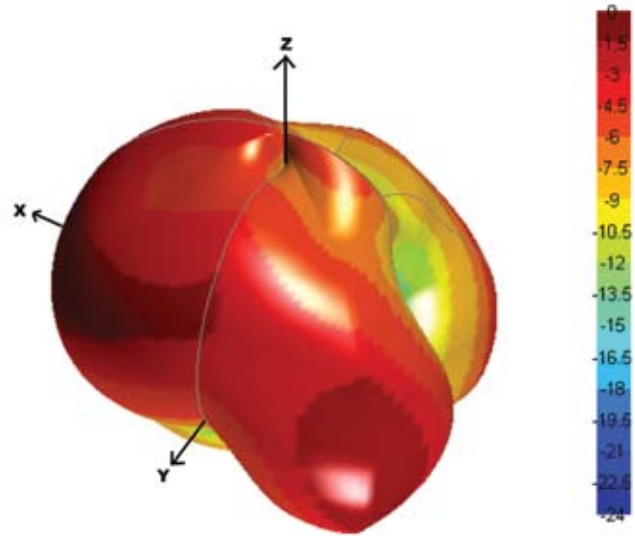
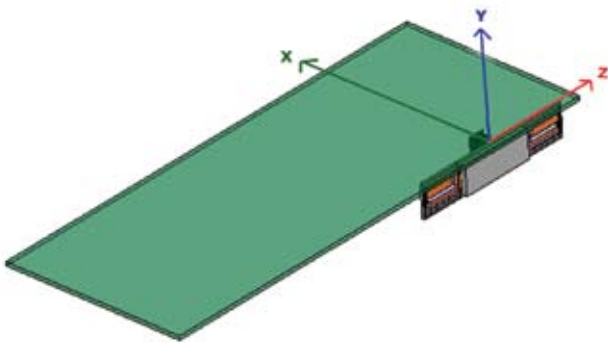

Return Loss

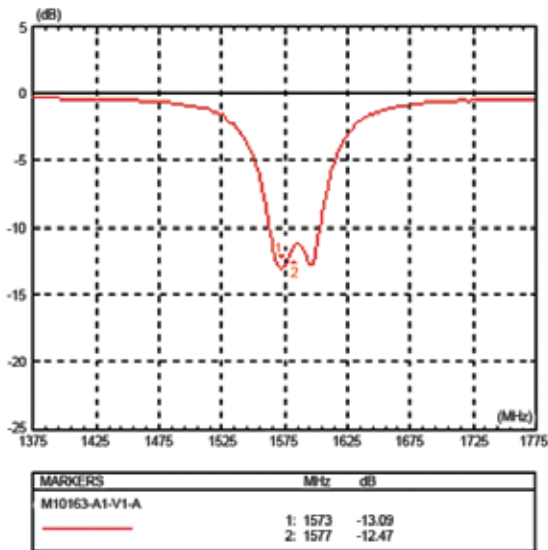

Efficiency

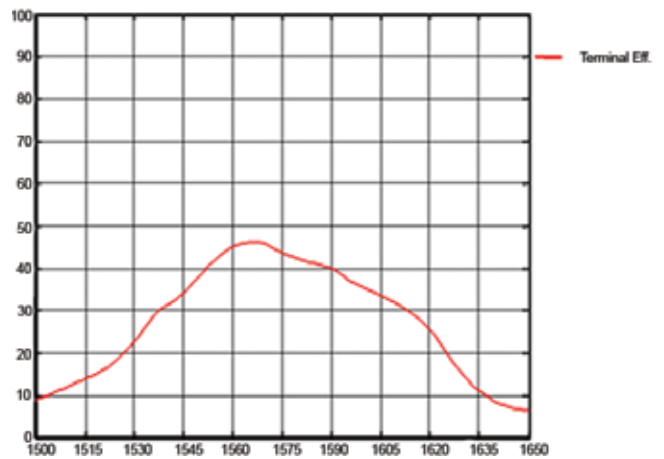



www.antenova.com

Corporate Headquarters

Antenova Ltd.

Far Field House
Albert Road
Stow-cum-Quy
Cambridge, CB25 9AR
UK

Tel: +44 (0) 1223 810600
Fax: +44 (0) 1223 810650
Email: sales@antenova.com

USA Headquarters

Antenova USA

Rogers Business Park
2541 Technology Drive, Suite 403
Elgin, IL 60124
USA

Tel: +1 (847) 551-9710
Fax: +1 (847) 551-9719
Email: sales@antenova.com

Asia Headquarters

Antenova Asia Ltd.

4F, No. 324, Sec. 1, Nei-Hu Road
Nei-Hu District
Taipei 11493
Taiwan, ROC

Tel: +886 (0) 2 8797 8630
Fax: +886 (0) 2 8797 6890
Email: sales@antenova.com

Copyright® 2007 Antenova Ltd. All Rights Reserved. Antenova® and RADIONOVA® are trademarks of Antenova Ltd. Any other names and/or trademarks belong to their respective companies.

The materials provided herein are believed to be reliable and correct at the time of print. Antenova does not warrant the accuracy or completeness of the information, text, graphics or other items contained within these information. Antenova further assumes no responsibility for the use of this information, and all such information shall be entirely at the user's risk.



Certificate No: 4598/04

Integrated Antenna Solutions